

AutoFlush®

for Tank Toilet

Wireless Model

Installation & Maintenance

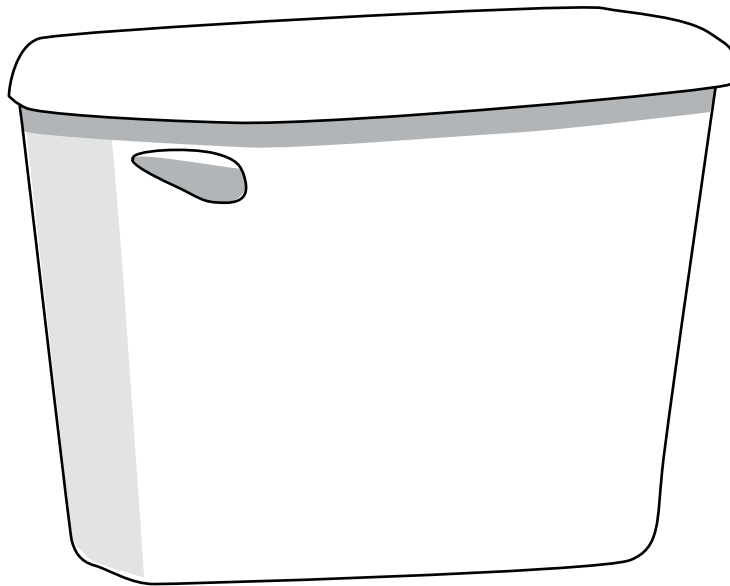
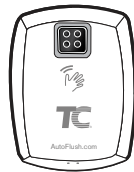

Important: Please Read Entire Instruction Booklet Before you Begin Installation !

Looks Clean - Is Clean.™



technical concepts

Innovative Hygiene Solutions

- A. Motor (Included with Remote Sensor)
- B. T-Handled Allen Wrench 490174
- C. Bead Chain with Clip 490169
- D. Remote Sensor - Chrome 490162
Remote Sensor - White 490163
- E. Sensor Cover Key 400845
- F. Battery Compartment 490165
- G. Battery Compartment screws and anchors (large - 2 ea) (Included)
- H. Wire Guides (3 ea) (Included)
- I. Screws and Anchors for Wire Guides (small - 3 ea) (Included)
- J. Four (4) "D" cell Alkaline Batteries
- K. Four (4) "AA" cell Alkaline Batteries
- L. Clear Plastic Shim (2 ea) 490185
- M. Double-sided Tape (Included) 400574
- N. Square Overflow Motor Mount Hanger (optional) 490356
- O. Motor Mount 'Y' Hanger 490355
- P. Motor Mount for Overflow Tube
- Q. Overflow Tube Plastic Spacer
- R. Overflow Pipe Clip

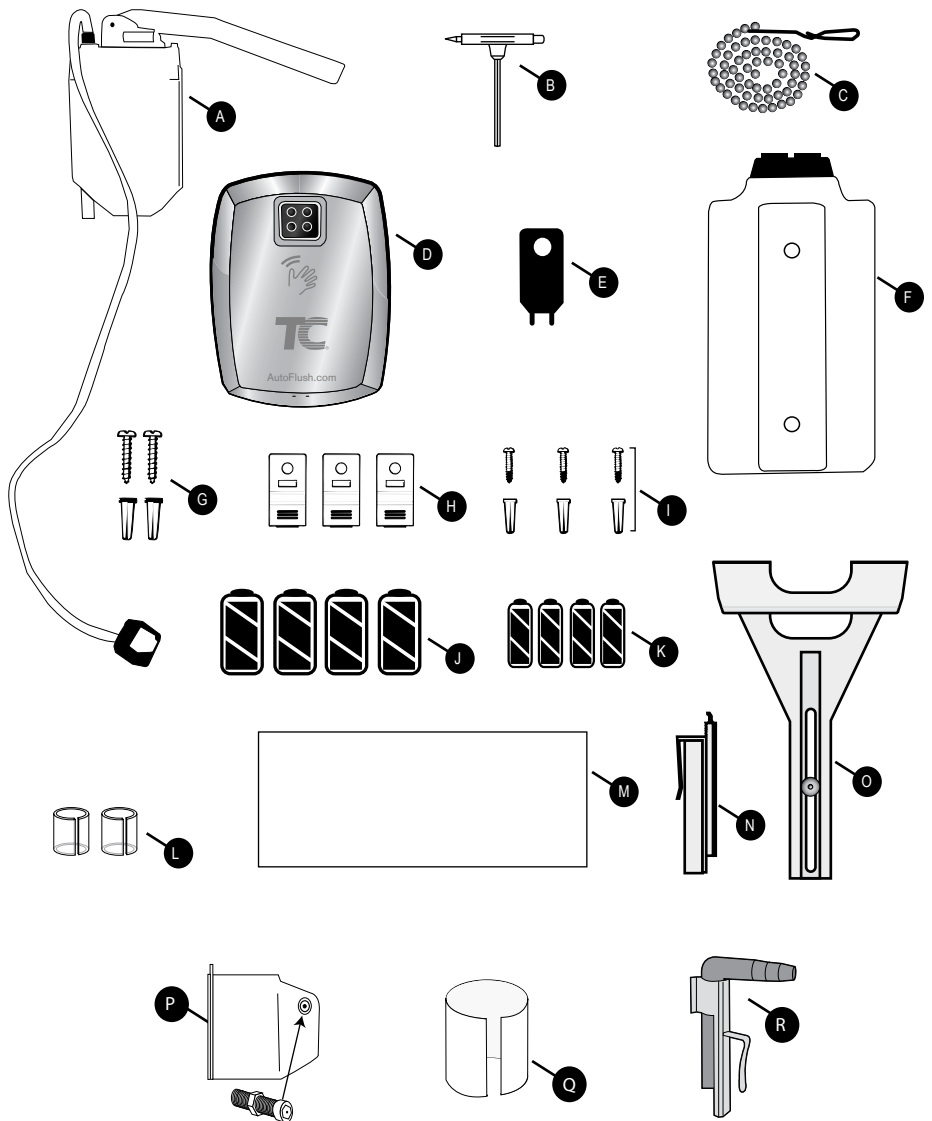

Tools required: Small Phillips screwdriver, pencil

Modes of Operation

The AutoFlush® comes with three modes of operation:

(A) Object Detection – toilet will flush 5 seconds after patron has left the sensing zone (32" factory setting). For an immediate flush the patron can wave their hand in front of the sensor.
This is the factory setting.

(B) Object Detection with Extended Delay – toilet will flush 7 seconds after patron has left the sensing zone (32" factory setting). For an immediate flush the patron can wave their hand in front of the sensor.

(C) Wave Only – toilet will flush only when the patron has waved their hand in front of the sensor.

1. Motor Mount Installation

1.1 For AutoFlush Tank to operate properly, make sure the tank level is level and plumb.

1.2 If your tank toilet fill-valve has a float ball we recommend replacing it with a Fluidmaster Fill-Valve. These are available for purchase from Technical Concepts or your local hardware store. See Fluidmaster instructions to install fill-valve.

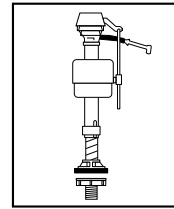

Recommended Fill-Valve

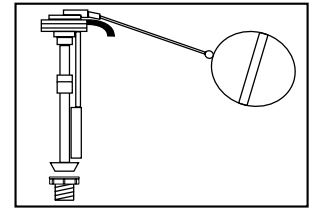

Not Recommended

1.3 Please check that the toilet is currently functioning properly. We recommend wearing protective gloves when working inside the toilet tank.

Is the water level set properly?

If not, properly adjust the water level. (HINT: Usually 3/4" to 1" below the top of overflow tube.)

Is the flapper leaking?

Add a couple of drops of blue food coloring into the tank water. Wait 15 minutes and then go back to see if the water in the bowl has turned blue. If yes, then replace the flapper.

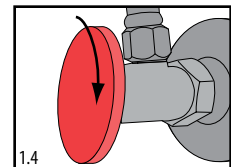

Do you have to hold the flush handle down to flush properly?

If yes, replace the flapper.

1.4 Turn off the water with the valve stop and flush the toilet to empty the water from the tank.

1.5 There are two types of flush valves; (1) Flapper type flush valves and (2) Tower type flush valves.

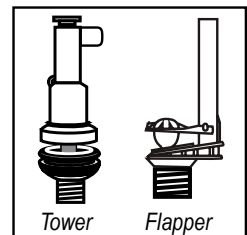

a. For Flapper type flush valves use the motor mount for overflow tube (P) kit.

NOTE: For Flapper type flush valves that have a square overflow tube use optional Square Overflow

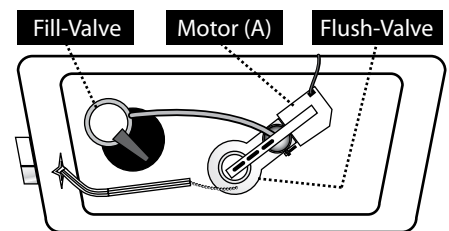
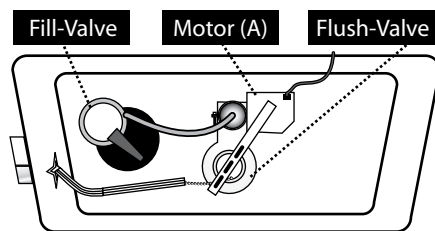
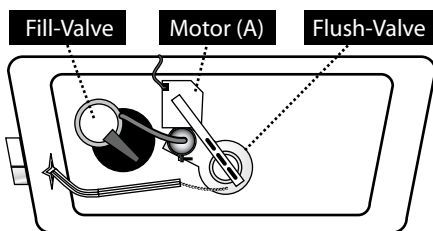

Motor Mount Hanger 490356. Install according to pictures below based on overflow tube position.

b. For Tower type flush valves use the motor mount 'Y' hanger (O). Install according to picture below.

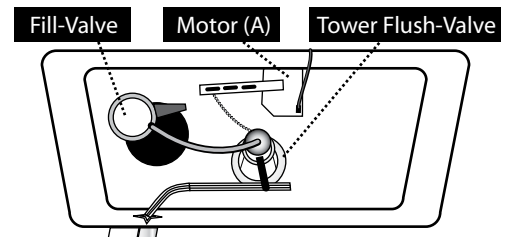

2. Motor Orientation

2.1 Slide the motor onto the motor mount until they click together.

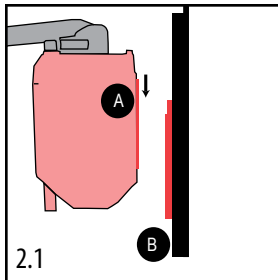

2.2 The top of the motor should be above the water level a minimum of 1 inch.

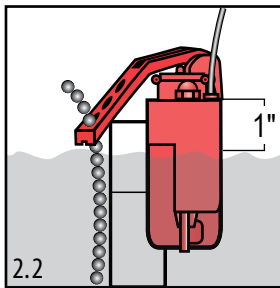

2.3 Rotate the actuator arm on the motor and align above the flapper. Align the arm and motor so they are not interfering with any of the internal plumbing components.

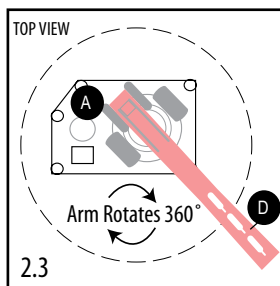

2.4 Attach the chain clip onto the flapper chain 2 inches above the flapper.

a. If you have a Tower type flush valve, connect the beaded chain clip to the D-ring on the back side of the flush valve.

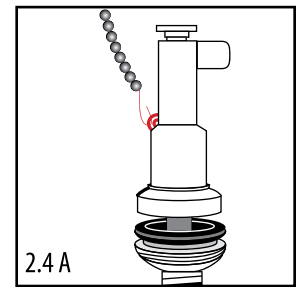
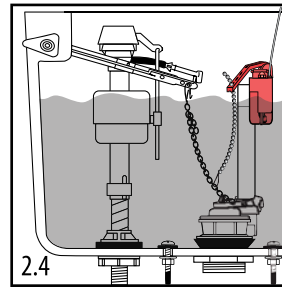

2.5 Determine which of the three (3) holes on the motor arm will give the best lift for the type of flush valve in your tank toilet. Thread the beaded chain through the selected hole and lock the chain into the hole slot. HINT: For Flapper type flush valves the total lift height should be approximately 2-1/2 inches. For Tower type flush valves the total lift height should be approximately 1-1/2 inches.

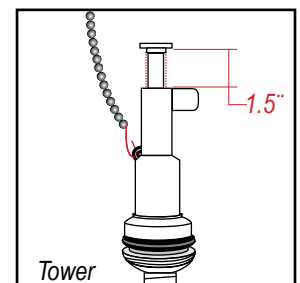
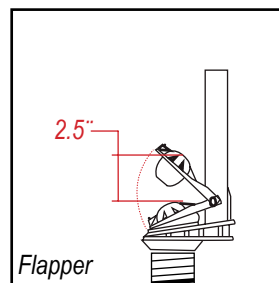
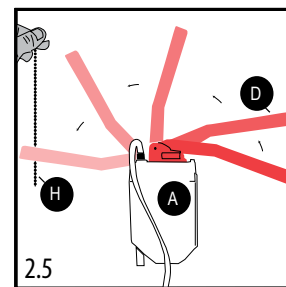

3. Remote Sensor Installation

3.1 There are 6 different types of toilet seats and various grab bar obstructions that require consideration before installing the sensor:

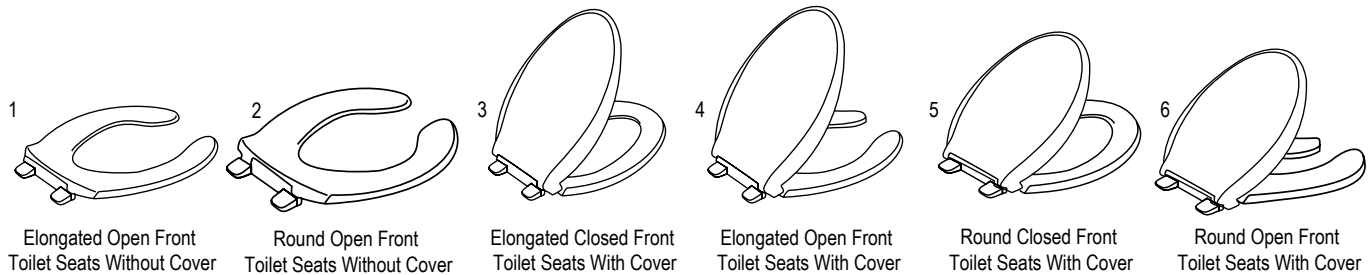

a. **Installation of the sensor for toilet seat types without covers 1 and 2**

Center the sensor horizontally and mount the bottom of the sensor 1" above the tank (3.1a & 3.1b). If a grab bar blocks the sensor lens, invert the sensor (3.1c). Peel the tape backing off of the sensor and mount according to picture 3.1a, 3.1b or 3.1c.

Note: With wallpaper or drywall installations use the mounting screws and wall anchors (G) provided (found in the battery compartment) to mount the remote sensor (D).

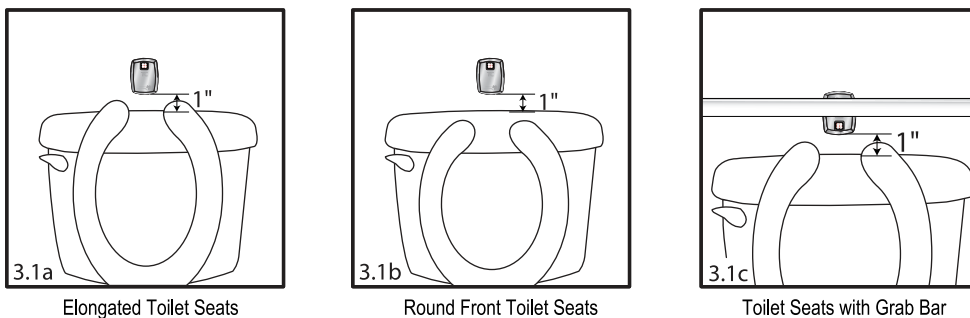

b. **Installation of the sensor for toilet seat types with covers 3,4,5 and 6**

Raise the toilet seat cover and mark the sensor lens location 1" above the toilet seat cover (3.1d). If the toilet seat cover does not come above the top of the toilet tank, then center the sensor horizontally and mount the bottom of the sensor 1" above the tank (3.1e). If a grab bar blocks the sensor lens, invert the sensor as shown above (3.1c). Peel the tape backing off of the sensor and mount according to picture 3.1c, 3.1d or 3.1e.

Note: With wallpaper or drywall installations use the mounting screws and wall anchors (G) provided (found in the battery compartment) to mount the remote sensor (D).

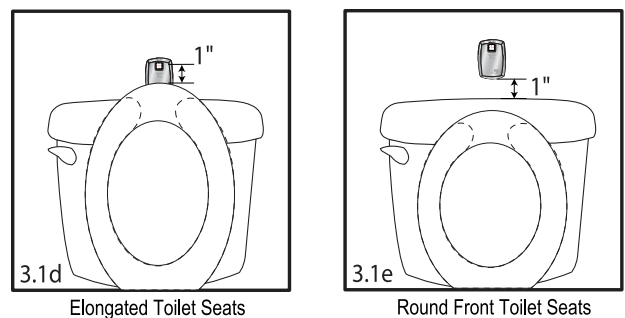

4. Install Remote Sensor Batteries and Battery Compartment

Remote Sensor Batteries

- 4.1 Remove the remote sensor cover (D) by taking the sensor cover key (E) and inserting it into the two small holes at the bottom. Push in and rotate up. Install the four (4) "AA" cell alkaline batteries (K). Replace cover on remote sensor.

Battery Compartment

- 4.2 Check to make sure the motor cord will reach the battery compartment before mounting.
- 4.3 Remove battery compartment cover by unscrewing the two Philips screws. Inside the battery box (F) there are two large screws and anchors (G). Place the battery compartment (F) in a convenient location under the tank, ensuring easy access.
- 4.4 Secure to wall with screws and anchors or double-sided tape (M).
Note: The battery compartment may be mounted using one screw and anchor with the top slot facilitating easy removal for battery replacement. Make sure the motor cord is placed in the notch at the back edge of the toilet tank (4.4a). If there is no notch, then use the two clear plastic shims (L)(4.4b).

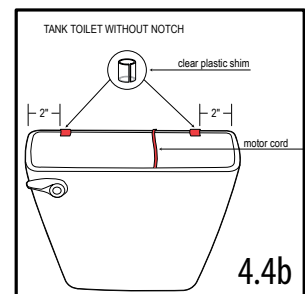

- 4.5 Plug in the cord from the motor (A) into the receptacle in the battery compartment. Then slide the rubber cover into place over the connection.
- 4.6 Install four (4) "D" cell alkaline batteries (J), noting the battery position marks on the inside of the compartment. Replace cover on battery box.

5. Activation

- 5.1 Turn water on and flush toilet with sensor to ensure flushing operation of toilet. Then replace the toilet tank cover.
- 5.2 The AutoFlush Sensor Range comes preset from the factory at 32". If special circumstances require adjustment of the activation range, see Appendix – Adjusting AutoFlush Range. The AutoFlush unit has a 7-minute start-up period in which the Object Lock Sensor will activate the User-In-View green LED, which will continuously blink as long as a user or object is in view. After the start-up sequence is completed and when the Object Lock Sensor has a user in view, the green LED will flash 3 times once the user is in front of the unit for a minimum of 5 seconds.

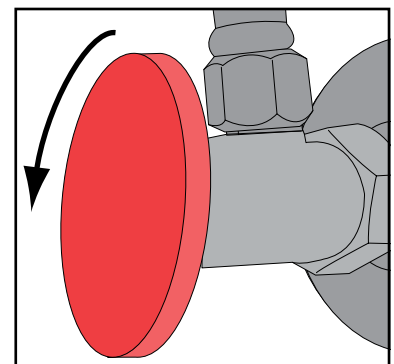

6. Settings

This unit comes factory set with 24 Hour Flush ON. This function will flush the fixture 24 hours after the last flush in the event that it is not used. This keeps the traps wet and helps prevent rings from hard water deposits in the bowl.

7. Troubleshooting

PROBLEM	CAUSE	SOLUTION TO PROBLEM
Green LED light flashes when there are no users.	Front of Object Detection Sensor is covered or Object Detection Range is set too far out, registering unwanted object.	Detection Sensor or adjust Object Detection activation range. (See Appendix - Adjusting the AutoFlush range)
Red LED light flashing on the battery box when not in use.	Batteries need replacing.	Replace sensor batteries. Requires 4 "D" Cell alkaline batteries.
The water in the toilet keeps running and tank does not refill.	<ol style="list-style-type: none">1) The rubber flapper is in need of repair2) The chains need adjustment or are tangled preventing the flapper from falling back into place.	<ol style="list-style-type: none">1) Replace the flapper.2) Readjust the chains and motor arm.
Not getting a full flush.	<ol style="list-style-type: none">1) Defective or incorrect flapper type. The flapper should slowly fall back into position and you do not need to hold the flush handle down to get a full flush2) Flapper chain needs to be adjusted.3) Motor arm is hitting the inside of the tank cover or is obstructed by the float arm.4) Chains are tangled.	<ol style="list-style-type: none">1) Replace the flapper.2) Readjust chain tension.3) Adjust motor and arm configuration for the unit to actuate without obstruction or reset overflow tube height.4) Adjust chain and motor arm positioning to avoid chains from intertwining.
Sensor is working but motor does not actuate.	<ol style="list-style-type: none">1) Check batteries in battery pack.2) Sensor is not actuating the motor unit.	<ol style="list-style-type: none">1) Replace batteries.2) Contact technical support at: 1-800-551-5155.

NOTE: Do not use tank type cleaners, which may damage the motor housing and other tank components.

Appendix - Adjusting AutoFlush Range

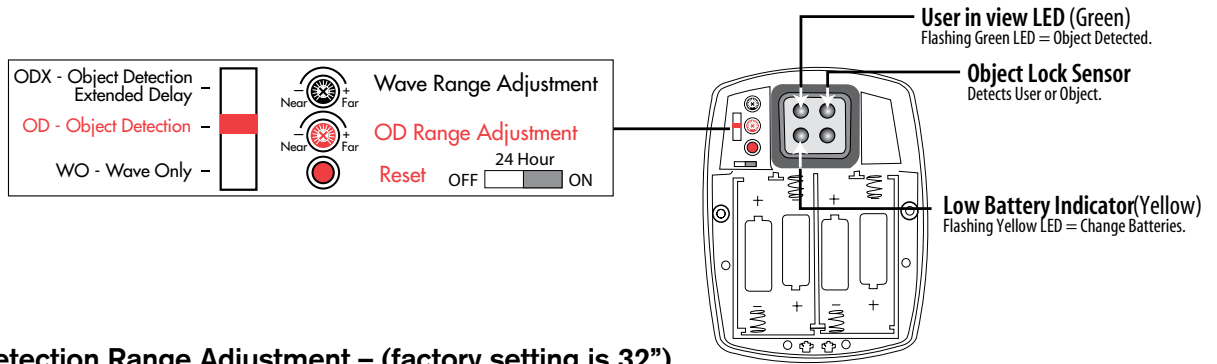

OD - Object Detection Range Adjustment – (factory setting is 32”)

ODX - Object Detection Extended Delay Range Adjustment – (factory setting is 32”)

1. Remove the cover of the sensor assembly with the sensor cover key (E).
2. Remove the rubber seal located on the left side of the sensor lens.
3. Press sensor range reset button shown in above diagram.
NOTE: The green LED will flash continuously when it has an object in view during the seven minute reset period. This allows you to select the correct range.
4. Hold a white piece of paper in front of the sensor. Slowly back the paper away until the green light stops, to determine if the sensor range needs to be adjusted Near or Far (max range = 48”).
5. Use the sensor adjustment tool to turn Object Detection (OD) Adjustment Screw as needed until the light flashes with the piece of paper held at the proper range.
6. Ensure Object Lock Sensor is not detecting unwanted objects by stepping out of sensor path making sure that the green LED is not flashing. If sensor locks onto an unwanted object, unit will not flush properly.
7. Replace sensor cover.
8. After the 7-minute reset period, the green LED will flashes 3 times when a user is in view (after the 3 second delay in OD mode or 5 second delay in ODX mode).

WO – Wave Only Range Adjustment – (factory setting is 2”)

1. Remove the cover of the sensor assembly with the sensor cover key (E).
2. Remove the rubber seal located on the left side of the sensor lens.
3. Press sensor range reset button shown in above diagram.
4. Place your hand at the required wave activation distance (max range = 6”).
5. Hold a white piece of paper in front of the sensor. Slowly back the paper away until the green light stops. Determine if the sensor range needs to be adjusted Near or Far.
6. Ensure Wave Only Sensor is not detecting unwanted objects by moving your hand out of sensor path and making sure the green LED does not turn on. If sensor locks onto an unwanted object, unit will not flush properly. Shorten activation distance.
7. Replace sensor cover.
8. After the 7-minute reset period, the green LED will turn on when your hand is in view.



technical concepts

Innovative Hygiene Solutions

World Headquarters:
Serving North and South America

Technical Concepts LLC
1301 Allanson Road
Mundelein, Illinois 60060 U.S.A.
Toll Free: 1-800-551-5155
Fax: 1-800-551-5046

www.technicalconcepts.com

European Headquarters:
Serving Europe, Africa and Middle East

Technical Concepts International Ltd.
Peterborough, PE2 6WA, England
Phone: +44 (0)870 568 6824

Asian Headquarters:
Serving Asia and Pacific

Technical Concepts Asia
14100, Penang, Malaysia
Phone: (60) 4 508 5008

